

Register your product and get support at  
[www.philips.com/welcome](http://www.philips.com/welcome)

AJ7030D

**STOP!**

Thank you for choosing Philips.

### Need help fast?

Read your Quick Start Guide and/or User Manual first for quick tips that make using your Philips product more enjoyable.

If you have read your instructions and still need assistance, you may access our online help at [www.philips.com/welcome](http://www.philips.com/welcome)

**ARRÊT!**

Philips vous remercie de votre confiance.

### Besoin d'une aide rapide?

Le Guide rapide de début et Manuel de l'utilisateur regorgent d'astuces destinées à simplifier l'utilisation de votre produit Philips.

Toutefois, si vous ne parvenez pas à résoudre votre problème, vous pouvez accéder à notre aide en ligne à l'adresse [www.philips.com/welcome](http://www.philips.com/welcome)

**ALTO!**

Gracias por escoger Philips

### Necesita ayuda inmediata?

Lea primero la Guía rápida del comienzo o el Manual del usuario, en donde encontrará consejos que le ayudarán a disfrutar plenamente de su producto Philips.

Si después de leerlo aún necesita ayuda, consulte nuestro servicio de asistencia en línea en [www.philips.com/welcome](http://www.philips.com/welcome)

---

## EN User manual

---



**PHILIPS**

A

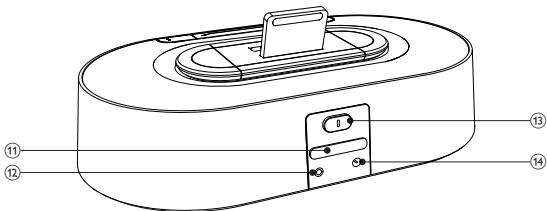
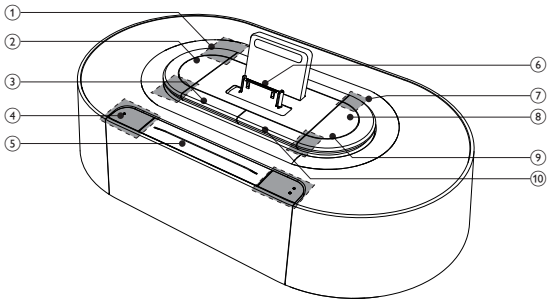

(B)

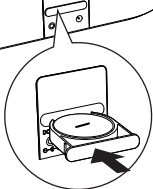
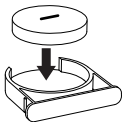
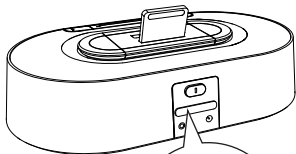

(C)

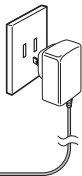
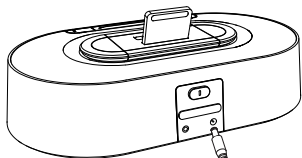

D

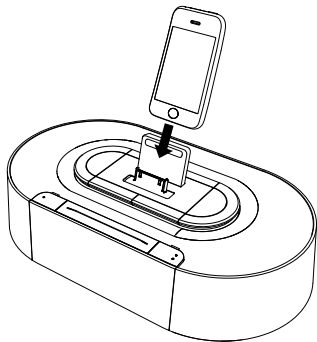

E

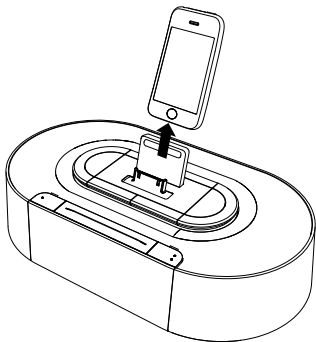

F

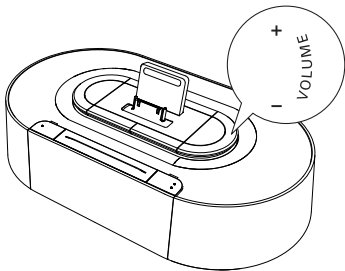

G



# Canada

## English:

This digital apparatus does not exceed the Class B limits for radio noise emissions from digital apparatus as set out in the Radio Interference Regulations of the Canadian Department of Communications. This Class B digital apparatus complies with Canadian ICES-003.

## Français:

Cet appareil numérique n'émet pas de bruits radioélectriques dépassant les limites applicables aux appareils numériques de Classe B prescrites dans le Règlement sur le Brouillage Radioélectrique édicté par le Ministère des Communications du Canada. Cet appareil numérique de la classe B est conforme à la norme NMB-003 du Canada.

**This product complies with the FCC-Rules, Part 15.**

**Operation is subject to the following two conditions:**

1. This device may not cause harmful interference, and
2. This device must accept any interference received, including interference that may cause undesired operation.

**L'appareil est conforme à la réglementation FCC, section 15. Son utilisation est soumise à deux conditions:**

1. L'appareil ne doit pas provoquer d'interférences nuisibles, et
2. L'appareil doit supporter les interférences reçues, y compris les interférences empêchant son fonctionnement correct.

# 1 Important

---

## Safety

---

### Important Safety Instructions

- ① Read these instructions.
- ② Keep these instructions.
- ③ Heed all warnings.
- ④ Follow all instructions.
- ⑤ Do not use this apparatus near water.
- ⑥ Clean only with dry cloth.
- ⑦ Do not block any ventilation openings. Install in accordance with the manufacturer's instructions.
- ⑧ Do not install near any heat sources such as radiators, heat registers, stoves, or other apparatus (including amplifiers) that produce heat.
- ⑨ Protect the power cord from being walked on or pinched, particularly at plugs, convenience receptacles, and the point where they exit from the apparatus.
- ⑩ Only use attachments/accessories specified by the manufacturer.

- ⑪ Use only with the cart, stand, tripod, bracket, or table specified by the manufacturer or sold with the apparatus. When a cart is used, use caution when moving the cart/apparatus combination to avoid injury from tip-over.



- ⑫ Unplug this apparatus during lightning storms or when unused for long periods of time.
- ⑬ Refer all servicing to qualified service personnel. Servicing is required when the apparatus has been damaged in any way, such as power-supply cord or plug is damaged, liquid has been spilled or objects have fallen into the apparatus, the apparatus has been exposed to rain or moisture, does not operate normally, or has been dropped.
- ⑭ **Battery usage CAUTION – To prevent battery leakage which may result in bodily injury, property damage, or damage to the unit:**
- Install all batteries correctly, + and - as marked on the unit.
  - Do not mix batteries (old and new or carbon and alkaline, etc.).
  - Remove batteries when the unit is not used for a long time.



- ⑮ Apparatus shall not be exposed to dripping or splashing.
- ⑯ Do not place any sources of danger on the apparatus (e.g. liquid filled objects, lighted candles).
- ⑰ This product may contain lead and mercury. Disposal of these materials may be regulated due to environmental considerations. For disposal or recycling information, please contact your local authorities or the Electronic Industries Alliance: [www.eiae.org](http://www.eiae.org).
- ⑱ Where the plug of the Direct Plug-in Adapter is used as the disconnect device, the disconnect device shall remain readily operable.

## 2 Your clock radio

Congratulations on your purchase, and welcome to Philips! To fully benefit from the support that Philips offers, register your product at [www.philips.com/welcome](http://www.philips.com/welcome).

---

### Introduction

With this clock radio, you can:

- listen to FM radio;
- enjoy audio from iPod/iPhone or an external device;
- know the time; and
- wake up by buzzer alarm, radio, or audio in iPod/iPhone.

---

# What's in the box

Check and identify the contents of your package:

- Main unit (with a battery)
  - AC adapter
  - User manual
- 

## Overview of the main unit (A)

- 1 PRESET▲▼**
  - Select a preset radio station.
  - Adjust hour and minute.
- 2 TUNING +/-**
  - Tune to a FM radio station.
  - Adjust hour and minute.
- 3 ①**
  - Turn on/off the clock radio.
  - Switch the clock radio to standby mode.
- 4 AL1/AL2**
  - Set alarm.
  - View alarm settings.
  - Activate/deactivate alarm timer.
- 5 SNOOZE/BRIGHTNESS**
  - Snooze alarm.
  - Adjust display brightness.
- 6 iPod/iPhone**
  - Dock for iPod/iPhone.
- 7 VOLUME +/-**
  - Adjust volume.
- 8 SET**
  - Store radio stations automatically/manually.

- Set clock.

### 9 SLEEP

- Set sleep timer.

### 10 SOURCE

- Select source.

### 11 Battery tray

### 12 AUX IN

- Connect an external audio device.

### 13 AL1/2 iPhone · RADIO · BUZZ

- Select alarm source.

### 14 DC 5V

- Power supply socket.

## 3 Get started

Always follow the instructions in this chapter in sequence.

---

### Install battery



#### Caution

- Risk of explosion! Keep batteries away from heat, sunshine or fire. Never discard batteries in fire.
- Danger of explosion if battery is incorrectly replaced. Replace only with the same or equivalent type.
- The battery contains chemical substances, so it should be disposed of properly.
- Keep children away from the battery.
- Perchlorate Material - special handling may apply. See [www.dtsc.ca.gov/hazardouswaste/perchlorate](http://www.dtsc.ca.gov/hazardouswaste/perchlorate).



## Note

- You can only use AC power as power supply. The pre-installed lithium CR2032 battery can only back up time and alarm.
- When power is disconnected, the display backlight is off.

### For first-time use:

Remove the protective tab to activate the battery.

To replace the battery: (B)

---

## Connect power (C)



### Caution

- Risk of product damage! Ensure that the power voltage corresponds to the voltage printed on the back or underside of the clock radio.
  - Risk of electric shock! When you unplug the AC adapter, always pull the plug from the socket. Never pull the cord.
- 

## Set clock

- 1 In standby mode, press and hold **SET** for two seconds to activate clock setting mode.  
↳ [12H] or [24H] is displayed.
- 2 Press **TUNING +/-** or **▲/▼** repeatedly to select 12/24 hour format.
- 3 Press **SET** again to confirm.  
↳ The hour digits begin to blink.
- 4 Repeat Steps 2 to 3 to set the hour and minute.



## Note

- If clock is not manually set, when iPod/iPhone is connected, the clock radio synchronizes time from the iPod/iPhone automatically.

---

## Turn on

Press ①.

- ↳ The clock radio switches to the last selected source.

---

## Switch to standby mode

Press ① to switch the clock radio to standby mode.

- ↳ The clock (if set) appears on the display panel.

# 4 Play from iPod/iPhone

You can enjoy audio from iPod/iPhone through this clock radio.

---

## Compatible iPod/iPhone

The clock radio supports these iPod and iPhone models:

Made for:

- iPod touch (1st, 2nd, 3rd, and 4th generation)
- iPod classic
- iPod with video
- iPod nano (1st, 2nd, 3rd, 4th, 5th, and 6th generation)
- iPod with color display
- iPod mini
- iPhone 4
- iPhone 3GS
- iPhone 3G

- iPhone

---

## Listen to audio from iPod/iPhone (D)

- 1 Press **SOURCE** repeatedly to select iPod/iPhone mode.
- 2 Place the iPod/iPhone in the dock.
- 3 Start to play audio from the iPod/iPhone.

---

## Remove the iPod/iPhone (E)

Pull the iPod/iPhone out of the dock.

---

## Charge the iPod/iPhone

When the clock radio is connected to power, the docked iPod/iPhone starts charging.

---

## Adjust volume (F)

---

# 5 Listen to FM radio

---

## Tune to FM radio stations



Tip

- Position the antenna as far as possible from TV, VCR, or other radiation source.
- For better reception, fully extend and adjust the position of the antenna.

- 1 Press **SOURCE** repeatedly to select FM tuner source.

- 2 Press and hold **TUNING +/-** for 2 seconds.  
↳ The clock radio tunes to a station with strong reception automatically.
- 3 Repeat step 2 to tune to more stations.

#### To tune to a station manually:

- 1 Press **TUNING +/-** repeatedly until you find optimal reception.

---

## Store FM radio stations automatically

You can store a maximum of 20 FM radio stations.  
In tuner mode, press and hold **SET** for two seconds.

- ↳ The clock radio stores all the available FM radio stations and broadcasts the first available station automatically.

---

## Store FM radio stations manually

- 1 Tune to an FM radio station.
- 2 Press **SET**.  
↳ The preset number begins to blink.
- 3 Press **PRESET ▲/▼** repeatedly to select a number.
- 4 Press **SET** again to confirm.
- 5 Repeat steps 1 to 4 to store other stations.



#### Note

- To remove a pre-stored station, store another station in its place.

---

## Select a preset radio station

In tuner mode, press **PRESET**▲/▼ to select a preset number.

---

# 6 Other features

---

## Set alarm timer

### Set alarm

In standby mode, you can set two alarms to ring at different time.



#### Note

- Make sure that you have set the clock correctly.

- 1 Press and hold **AL1/AL2** for two seconds to activate alarm setting mode.  
↳ The hour digits and alarm icon begin to blink.
- 2 Press **TUNING +/-** or ▲/▼ to set the hour.
- 3 Press **AL1/AL2** to confirm.  
↳ The minute digits begin to blink.
- 4 Repeat steps 2 to 3 to set the minute and alarm volume.



---

## Select alarm source

Adjust **AL1/2 iPhone·RADIO·BUZZ** control to select alarm source for both alarms.





### Note

- When alarm time comes, the selected radio, buzzer, or iPod/iPhone turns on.
- You can only select the same alarm source for Alarm 1/ Alarm2.
- If iPhone is selected as alarm source, while no iPod/iPhone is connected, the clock radio switches to buzzer source instead.

---

## Activate/deactivate alarm timer

- 1 Press **AL1/AL2** to view alarm settings.
- 2 Press **AL1/AL2** again to activate or deactivate the alarm timer:
  - ↳  or  appears if alarm timer is on and disappears if it is off.
  - To stop the ringing alarm, press the corresponding **AL1/AL2**.
  - The alarm repeats ringing for the next day.

---

## Snooze alarm

When alarm sounds, press **SNOOZE**.

- ↳ The alarm snoozes and repeats ringing five minutes later.

To adjust alarm interval (in minutes), press **SNOOZE** repeatedly.

---

## Set sleep timer

This clock radio can switch to standby mode automatically after a preset period.

Press **SLEEP** repeatedly to select the sleep timer period (in minutes).

↳ When the sleep timer is activated, **zZ** appears.

To deactivate the sleep timer, press **SLEEP** repeatedly until **[OFF]** (off) appears.

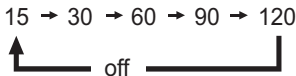

---

## Play audio from an external device

You can listen to audio from an external device through this clock radio.

- 1 Connect the audio cable to:
  - the **AUX IN** socket.
  - the audio output sockets of an external device.
- 2 Press **SOURCE** repeatedly to select AUX source.  
↳  is displayed.
- 3 Start to play the external device (see the user manual of this device).

---

## Adjust display brightness

Press **BRIGHTNESS** repeatedly to select different brightness levels.

# 7 Product information



### Note

- Product information is subject to change without prior notice.

---

## Specifications

### Amplifier

Rated Output Power	2 X 3W RMS
--------------------	------------

### Tuner

Tuning Range	FM: 87.5 - 108 MHz
--------------	--------------------

Sensitivity - Mono, 26dB S/N Ratio	FM: <22 dBf
---------------------------------------	-------------

Search Selectivity	FM: <28 dBf
--------------------	-------------

Total Harmonic Distortion	FM: <2%
---------------------------	---------

Signal to Noise Ratio	FM: >55 dB
-----------------------	------------

---

---

## General information

---

AC Power	Model:ASSA1A-050200; Output:5V 2A
----------	--------------------------------------

---

Operation Power Consumption	8 W
-----------------------------	-----

---

Standby Power Consumption	<1 W
---------------------------	------

---

Dimensions

- Main Unit (W x H x D)	198 x 71 x 111 mm
-------------------------	-------------------

---

Weight

- With Packing	0.9 kg
- Main Unit	0.5 kg

---

## 8 Troubleshooting



### Warning

- Never remove the casing of this apparatus.

To keep the warranty valid, never try to repair the system yourself.

If you encounter problems when using this apparatus, check the following points before requesting service. If the problem remains unsolved, go to the Philips web site ([www.philips.com/welcome](http://www.philips.com/welcome)). When you contact Philips, ensure that the

apparatus is nearby and the model number and serial number are available.

### **No power**

- Ensure that the AC power plug of the clock radio is connected properly.
- Ensure that there is power at the AC outlet.

### **No response from the clock radio**

- Disconnect and reconnect the AC power plug, then turn on the clock radio again.

### **Poor radio reception**

- Increase the distance between the unit and your TV or VCR.
- Fully extend the FM antenna.

### **Alarm does not work**

- Set the clock/alarm correctly.

### **Clock/alarm setting erased**

- Power has been interrupted or the power plug has been disconnected.
- Reset the clock/alarm.

## **9 Notice**

Any changes or modifications made to this device that are not expressly approved by Philips Consumer Lifestyle may void the user's authority to operate the equipment.

---

## Disposal of your old product and batteries

Your product is designed and manufactured with high quality materials and components, which can be recycled and reused. Never dispose of your product with other household waste. Please inform yourself about the local rules on the separate collection of electrical and electronic products and batteries. The correct disposal of these products helps prevent potentially negative consequences on the environment and human health.

Your product contains batteries, which cannot be disposed of with normal household waste.

Please inform yourself about the local rules on separate collection of batteries. The correct disposal of batteries helps prevent potentially negative consequences on the environment and human health.

Please visit [www.recycle.philips.com](http://www.recycle.philips.com) for additional information on a recycling center in your area.

### **Environmental information**

All unnecessary packaging has been omitted. We have tried to make the packaging easy to separate into three materials: cardboard (box), polystyrene foam (buffer) and polyethylene (bags, protective foam sheet.)

Your system consists of materials which can be recycled and reused if disassembled by a specialized company. Please observe the local regulations regarding the disposal of packaging materials, exhausted batteries and old equipment.

Made for



iPod



iPhone

“Made for iPod” and “Made for iPhone” mean that an electronic accessory has been designed to connect specifically to iPod or iPhone respectively, and has been certified by the developer to meet Apple performance standards. Apple is not responsible for the operation of this device or its compliance with safety and regulatory standards. Please note that the use of this accessory with iPod or iPhone may affect wireless performance.

iPod and iPhone are trademarks of Apple Inc., registered in the U.S. and other countries.



#### Note

- The type plate is located on the bottom of the apparatus.

2011 © Koninklijke Philips Electronics N.V. All rights reserved. Specifications are subject to change without notice. Trademarks are the property of Koninklijke Philips Electronics N.V. or their respective owners. Philips reserves the right to change products at any time without being obliged to adjust earlier supplies accordingly.

Register online at [www.philips.com/welcome](http://www.philips.com/welcome) today to  
get the very most from your purchase.

Registering your model with PHILIPS makes you eligible for all of the valuable benefits listed below, so don't miss out.  
Register online at [www.philips.com/welcome](http://www.philips.com/welcome) to ensure:

### \*Product Safety Notification

By registering your product, you'll receive notification - directly from the manufacturer.

### \*Additional Benefits

Registering your product guarantees that you'll receive all of the privileges to which you're entitled, including special money-saving offers.

# PHILIPS

*Congratulations on your purchase,  
and welcome to the "family!"*

#### Dear PHILIPS product owner:

Thank you for your confidence in PHILIPS. You've selected one of the best-built, best-backed products available today. We'll do everything in our power to keep you happy with your purchase for many years to come.

As a member of the PHILIPS "family," you're entitled to protection by one of the most comprehensive warranties in the industry. What's more, your purchase guarantees you'll receive all the information and special offers for which you qualify, plus easy access to accessories from our convenient home shopping network.

Most importantly, you can count on our uncompromising commitment to your total satisfaction.

All of this is our way of saying welcome - and thanks for investing in a PHILIPS product.

**P.S. To get the most from your PHILIPS purchase, be sure to register online at:**

[www.philips.com/welcome](http://www.philips.com/welcome)

Know these  
**safety** symbols



**⚡** This "bolt of lightning" indicates uninsulated material within your unit may cause an electrical shock. For the safety of everyone in your household, please do not remove product covering.

**!** The "exclamation point" calls attention to features for which you should read the enclosed literature closely to prevent operating and maintenance problems.

**WARNING:** To reduce the risk of fire or electric shock, this apparatus should not be exposed to rain or moisture and objects filled with liquids, such as vases, should not be placed on this apparatus.

**CAUTION:** To prevent electric shock, match wide blade of plug to wide slot, fully insert.

**ATTENTION:** Pour éviter les choc électriques, introduire la lame la plus large de la fiche dans la borne correspondante de la prise et pousser jusqu'au fond.

#### For Customer Use

Enter below the Serial No. which is located on the rear of the cabinet. Retain this information for future reference.

Model No. \_\_\_\_\_

Serial No. \_\_\_\_\_

**PHILIPS**

Visit our World Wide Web Site at <http://www.philips.com/welcome>



# PHILIPS LIMITED WARRANTY

## ONE (1) YEAR

### WARRANTY COVERAGE:

PHILIPS warranty obligation is limited to the terms set forth below.

### WHO IS COVERED:

Philips warrants the product to the original purchaser or the person receiving the product as a gift against defects in materials and workmanship as based on the date of original purchase ("Warranty Period") from an Authorized Dealer. The original sales receipt showing the product name and the purchase date from an authorized retailer is considered such proof.

### WHAT IS COVERED:

The Philips warranty covers new products if a defect in material or workmanship occurs and a valid claim is received by Philips within the Warranty Period. At its option, Philips will either (1) repair the product at no charge, using new or refurbished replacement parts, or (2) exchange the product with a product that is new or which has been manufactured from new, or serviceable used parts and is at least functionally equivalent or most comparable to the original product in Philips current inventory, or (3) refund the original purchase price of the product.

Philips warrants replacement products or parts provided under this warranty against defects in materials and workmanship from the date of the replacement or repair for ninety (90) days or for the remaining portion of the original product's warranty, whichever provides longer coverage for you. When a product or part is exchanged, any replacement item becomes your property and the replaced item becomes Philips' property. When a refund is given, your product becomes Philips' property.

**Note: Any product sold and identified as refurbished or renewed carries a ninety (90) day limited warranty.**

**Replacement product can only be sent if all warranty requirements are met. Failure to follow all requirements can result in delay.**

### WHAT IS NOT COVERED - EXCLUSIONS AND LIMITATIONS:

This Limited Warranty applies only to the new products manufactured by or for Philips that can be identified by the trademark, trade name, or logo affixed to it. This Limited Warranty does not apply to any non-Philips hardware product or any software, even if packaged or sold with the product. Non-Philips manufacturers, suppliers, or publishers may provide a separate warranty for their own products packaged with the bundled product.

Philips is not liable for any damage to or loss of any programs, data, or other information stored on any media contained within the product, or any non-Philips product or part not covered by this warranty. Recovery or reinstallation of programs, data or other information is not covered under this Limited Warranty.

This warranty does not apply (a) to damage caused by accident, abuse, misuse, neglect, misapplication, or non-Philips product, (b) to damage caused by service performed by anyone other than Philips or Philips Authorized Service Location, (c) to a product or a part that has been modified without the written permission of

Philips, or (d) if any Philips serial number has been removed or defaced, or (e) product, accessories or consumables sold "AS IS" without warranty of any kind by including refurbished Philips product sold "AS IS" by some retailers.

### This Limited Warranty does not cover:

- Shipping charges to return defective product to Philips.
- Labor charges for installation or setup of the product, adjustment of customer controls on the product, and installation or repair of antenna/signal source systems outside of the product.
- Product repair and/or part replacement because of improper installation or maintenance, connections to improper voltage supply, power line surge, lightning damage, retained images or screen markings resulting from viewing fixed stationary content for extended periods, product cosmetic appearance items due to normal wear and tear, unauthorized repair or other cause not within the control of Philips.
- Damage or claims for products not being available for use, or for lost data or lost software.
- Damage from mishandled shipments or transit accidents when returning product to Philips.
- A product that requires modification or adaptation to enable it to operate in any country other than the country for which it was designed, manufactured, approved and/or authorized, or repair of products damaged by these modifications.
- A product used for commercial or institutional purposes (including but not limited to rental purposes).
- Product lost in shipment and no signature verification receipt can be provided.
- Failure to operate per Owner's Manual.

### TO OBTAIN ASSISTANCE IN THE U.S.A., PUERTO RICO, OR U.S. VIRGIN ISLANDS...

Contact Philips Customer Care Center at:  
1-888-PHILIPS (1-888-744-5477)

### TO OBTAIN ASSISTANCE IN CANADA...

1-800-661-6162 (French Speaking)  
1-888-PHILIPS (1-888-744-5477) - (English or Spanish Speaking)

REPAIR OR REPLACEMENT AS PROVIDED UNDER THIS WARRANTY IS THE EXCLUSIVE REMEDY FOR THE CONSUMER. PHILIPS SHALL NOT BE LIABLE FOR ANY INCIDENTAL OR CONSEQUENTIAL DAMAGES FOR BREACH OF ANY EXPRESS OR IMPLIED WARRANTY ON THIS PRODUCT. EXCEPT TO THE EXTENT PROHIBITED BY APPLICABLE LAW, ANY IMPLIED WARRANTY OF MERCHANTABILITY OR FITNESS FOR A PARTICULAR PURPOSE ON THIS PRODUCT IS LIMITED IN DURATION TO THE DURATION OF THIS WARRANTY.

Some states do not allow the exclusions or limitation of incidental or consequential damages, or allow limitations on how long an implied warranty lasts, so the above limitations or exclusions may not apply to you.

*This warranty gives you specific legal rights. You may have other rights which vary from state/province to state/province.*

Philips Consumer Lifestyle  
A division of Philips Electronics North America Corporation  
P.O. Box 10313  
Stamford, CT 06904  
Phone: 1-888-PHILIPS (744-5477)

Meet Philips at the Internet  
<http://www.philips.com/welcome>



© 2011 Koninklijke Philips Electronics N.V.

All rights reserved.

AJ7030D\_37\_UM\_V1.4

